

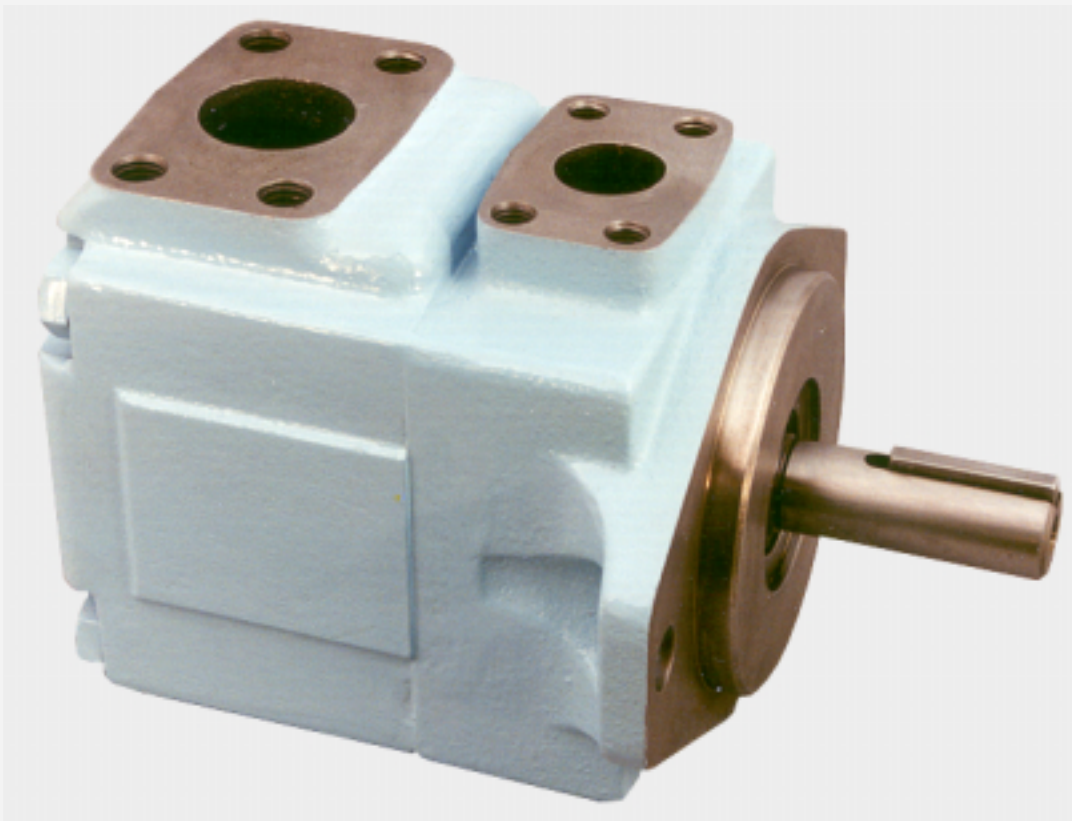

Vane pumps single, double & triple T6 mobile application



Publ. 1 - AM0701 - A 11 / 98 / 2000 / FB Replaces : 1 - AM 075 - A



FEATURES - T6 SERIES MOBILE APPLICATION

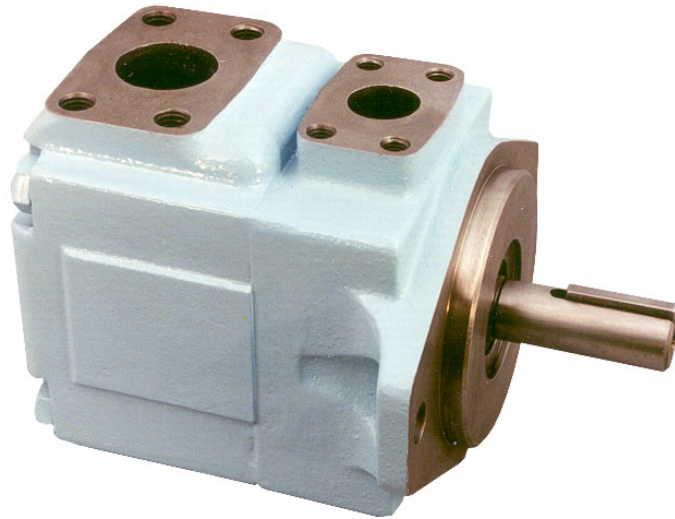

GREATER FLOW

Greater flow for the envelope size is achieved by increased displacement cam rings : at high permissible speeds with atmospheric inlet

C → 3 to 31 GPM, .66 to 6.10 in³/rev.

D → 14 to 50 GPM, 2.90 to 9.64 in³/rev.

E → 42 to 72 GPM, 8.07 to 13.86 in³/rev.

HIGHER PRESSURE

Pressure ratings to 4000 PSI reduce size and cost of actuators, valves and lines, give extended life at reduced pressures.

BETTER EFFICIENCY

Better efficiency under load increases productivity, reduces heating and operating costs.

MOUNTING FLEXIBILITY

Up to 32 positions for double pumps and up to 128 for triple pumps: this reduces mounting costs and improves performance.

LOWER NOISE LEVELS

Increase operator safety and acceptance.

COMPLETE CONFORMITY

To SAE - J744c 2-bolt standards and to ISO 3019-1 (T6EDCS SAE E, T6EDCM ISO 3019/2) in the various keyed and splined shaft options offered.

CARTRIDGE DESIGN

Provides for drop-in assemblies. This allows easy conversion or renewal of serviceable elements in minutes at minimum expense and risk of contamination. The "C" & "D" cartridge pumps are birotational and indicated by "B" description in cartridge model number. Pump rotation is easy to change by changing position of cam ring on port plate dowel pin hole.

WIDER RANGE OF ACCEPTABLE VISCOSITIES

Viscosities from 9240 to 60 SUS permit colder starts and hotter running. The balanced design compensates for wear and temperature changes. At high viscosity or cold temperature, the rotor to side plates gap is well lubricated and improves mechanical efficiency.

FIRE RESISTANT FLUIDS

Including phosphate esters, chlorinated hydrocarbons, water glycols and invert emulsions may be pumped at higher pressures and with longer service life by these pumps.

GENERAL APPLICATIONS INSTRUCTIONS

1. Check speed range, pressure, temperature, fluid quality, viscosity and pump rotation.
2. Check inlet conditions of the pump, if it can accept application requirement.
3. Type of shaft : if it would support operating torque.
4. Coupling must be chosen to minimize pump shaft load (weight, misalignment).
5. Filtration : must be adequate for lowest contamination level.
6. Environment of pump : to avoid noise reflection, pollution and shocks.

MINIMUM & MAXIMUM SPEED, PRESSURE RATINGS - T6 SERIES MOBILE APPLICATION

Size	Series	Theoretical Displacement Vi in ³ /rev	Minimum Speed RPM	Maximum Speed		Maximum Pressure					
				HF-0, HF-1 HF-2	HF-3, HF-4 HF-5	HF-0, HF-2		HF-1, HF-4, HF-5		HF-3	
				RPM	RPM	Int. PSI	Cont. PSI	Int. PSI	Cont. PSI	Int. PSI	Cont. PSI
CM CP	B03	.66	400	2800	1800	4000	3500	3000	2500	2500	2000
	B05	1.05									
	B06	1.30									
	B08	1.61									
	B10	2.08									
	B12	2.26									
	B14	2.81									
	B17	3.56									
	B20	3.89									
	B22	4.29									
	B25	4.84									
	B28	5.42		2500			3000	2300		2300	
	B31	6.10									
DM DP	B14	2.90	400	2500	1800	3500	3000	3000	2500	2500	2000
	B17	3.55									
	B20	4.03									
	B24	4.85									
	B28	5.47									
	B31	6.00									
	B35	6.77									
	B38	7.34									
	B42	8.30									
	B45	8.89									
	B50	9.64									
				2200			3000	2300		2300	
EM EP	042	8.07	400	2200	1800	3500	3000	3000	2500	2500	2000
	045	8.69									
	050	9.67									
	052	10.06									
	062	12.00									
	066	13.02									
	072	13.86									

HF-0, HF2 = Antiwear Petroleum Base
 HF-1 = Non Antiwear Petroleum Base
 HF-5 = Synthetic Fluids
 HF-3 = Water in oil Emulsions
 HF-4 = Water Glycols

For further information or if the performance characteristics outlined above do not meet your own particular requirements, please consult your local DENISON Hydraulics office.

PRIMING AT STARTING

At first, start operation of the pump shaft at the lowest speed and at the lowest pressure to obtain priming. When a pressure relief valve is used at the outlet, it should be backed off to minimize return pressure.
 When possible, an air bleed off should be provided in the circuit to facilitate purging of system air.
 Never operate pump shaft at top speed and pressure without checking for completion of pump priming, and the fluid has no aeration disaerated.

MINIMUM ALLOWABLE INLET PRESSURE (PSI ABSOLUTE) - T6 SERIES MOBILE APPLICATION

Cartridge		Speed RPM								Series				
Size	Series	1200	1500	1800	2100	2200	2300	2500	2800					
CM CP	B03	11.6	11.6	11.6	11.6	11.6	11.6	13.0	14.5	B03				
	B05									B05				
	B06									B06				
	B08									B08				
	B10									B10				
	B12									12.3	13.3	B12		
	B14									B14				
	B17									12.3	13.7	14.9	B17	
	B20									13.0	14.2	15.2	B20	
	B22									13.0	13.7	13.7	15.2	B22
	B25									14.5	14.5	15.7	B25	
	B28									12.3	13.0	14.5	16.1	B28
	B31									B31				
DM DP	B14	11.6	11.6	11.6	11.6	12.8	13.7	14.5	15.2	B14				
	B17				B17									
	B20				B20									
	B24				11.9					15.9	B24			
	B28				12.3					13.3	14.5	17.1	B28	
	B31				13.0					13.7	17.8	B31		
	B35				13.3					14.2	14.8	18.7	B35	
	B38				13.7					14.5	15.2	B38		
	B42				14.8					15.7	B42			
	B45				12.3					14.2	115.2	B45		
	B50				14.8					15.8	B50			
EM EP	042	11.6	11.6	11.6	12.8	14.5	15.8	15.2	15.2	042				
	045				045									
	050				050									
	052				052									
	062				12.3					13.7	062			
	066				12.3					12.3	13.7	14.5	15.8	066
	072				12.3					12.3	13.7	14.5	15.2	072

Inlet pressure is measured at inlet flange with petroleum base fluids at viscosity between 60 and 300 SUS. The difference between inlet pressure at the pump flange and atmospheric pressure must not exceed 2.9 PSI to prevent aeration.

Multiply absolute pressure by 1,25 for HF-3, HF-4 fluids.
by 1,35 for HF-5 fluid.
by 1,10 for ester or rapeseed base.

Use highest cartridge absolute pressure for double & triple pump.

GENERAL CHARACTERISTICS

	Mounting standard	Weight without connector and bracket - Lbs	Moment of inertia Lb.in ²	SAE 4 bolts J518c - ISO/DIS 6162-1 - ⁴⁾ ISO/DIS 6162-2			
				Suction	Pressure		
T6CM	SAE J744c ISO/3019-1 SAE B	34.0	2.6	1"1/2	1"		
T6CP	SAE J744c ISO/3019-1 SAE C	39.7	2.7	2" ⁴⁾	1"1/4 ⁴⁾		
T6D*		53.0	7.9	2"	1"1/4		
T6E*		95.0	16.6	3"	1"1/2		
T6CC*		57.3	5.1	2"1/2 or 3"	P1 1"	P2 1" or 3/4"	
T6DC*	SAE J744c ISO/3019-1 SAE C	80.7	10.4	3"	1"1/4	1"	
T6EC*		121.0	25.0	3"1/2	1"1/2	1"	
T6ED*		145.5	25.0	4"	1"1/2	1"1/4	
T6DCC*		134.5	12.7	4"	P1 1"1/4	P2 1"	P3 1" or 3/4"
T6EDC*	SAE "E" (T6EDCS) ISO/3019-2 (T6EDCM)	220.4	27.4	4"	1"1/2	1"1/4	1" or 3/4"

CALCULATION

To resolve

Volumetric displacement V_i [in³/rev.]
 Available flow q_v [GPM]
 Input power P [HP]

Performances required

Requested flow q_v [GPM] 15.8
 Speed n [R.P.M.] 1500
 Pressure p [PSI] 2200

ROUTINE AND EXAMPLE

Routine :

Example :

1. First calculation $V_i = \frac{231 Q}{n}$

$V_i = \frac{231 \times 15.8}{1500} = 2.43 \text{ in}^3/\text{rev.}$

2. Choice V_i of pump immediately greater (see tabulation)

T6CM B14 $V_i = 2.81 \text{ in}^3/\text{rev.}$

3. Theoretical flow of this pump
 $q_{v_i} = \frac{V_i \times n}{231}$

$q_{v_i} = \frac{2.81 \times 1500}{231} = 18.2 \text{ GPM}$

4. Find q_{v_s} leakage function of pressure $q_{v_s} = f(p)$ on curve at 60 or 115 SUS

T6CM (page 10) : $q_{v_s} = 1.3 \text{ GPM}$ at 2200 PSI, 115 SUS

5. Available flow $q_{v_e} = q_{v_i} - q_{v_s}$

$q_{v_e} = 18.2 - 1.3 = 16.9 \text{ GPM}$

6. Theoretical input power
 $P_i = \frac{q_{v_i} \times p}{1714}$

$P_i = \frac{18.2 \times 2200}{1714} = 23.4 \text{ HP}$

7. Find p_s hydrodynamic power loss on curve

T6CM (page10) : P_s at 1500 R.P.M., 2200 PSI = 2.1 HP

8. Calculation of necessary input power $P = P_i + P_s$

$P = 23.4 + 2.1 = 25.5 \text{ HP}$

9. Results

$V_i = 2.81 \text{ in}^3/\text{rev}$
 $q_{v_e} = 16.96 \text{ GPM}$ T6CM B14
 $P = 25,50 \text{ HP}$

These calculation steps must be followed for each application.

INTERMITTENT PRESSURE RATING

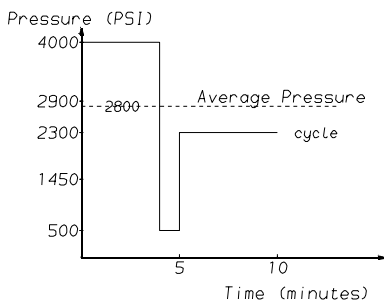

T6 units may be operated intermittently at pressures higher than the recommended continuous rating when the time weighted average of pressure is less than or equal to the continuous duty pressure rating.

This intermittent pressure rating calculation is only valid if other parameters; speed, fluid, viscosity and contamination level are respected.

For total cycle time higher than 15 minutes, please consult your DENISON Hydraulics representative.

Example : T6CM - B14

Duty cycle 4 min. at 4000 PSI
 1 min. at 500 PSI
 5 min. at 2300 PSI

$$\frac{(4 \times 4000) + (1 \times 500) + (5 \times 2300)}{10} = 2800 \text{ PSI}$$

2800 PSI is lower than 3500 PSI allowed as continuous pressure for T6CM - B14 with HF-0 fluid.

DESCRIPTION - T6 SERIES MOBILE APPLICATION

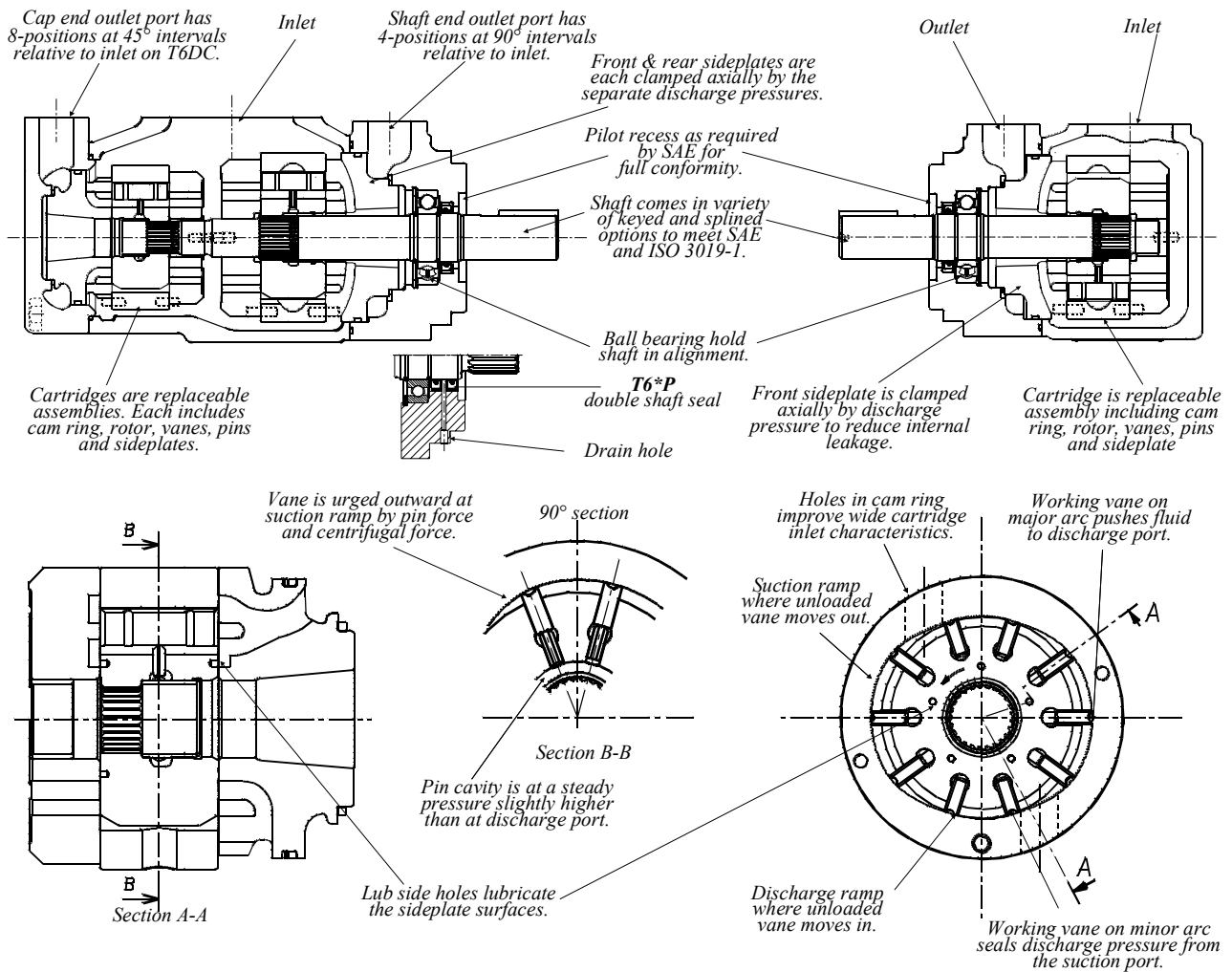

APPLICATION ADVANTAGES

- The high pressure capability to 4000 PSI, in the small envelope, reduces installation costs and provides extended life at reduced pressure.
- The high volumetric efficiency, typically 94%, reduces heat generation, and allows speeds down to 400 RPM at full pressure.
- The high mechanical efficiency, typically 94%, reduces energy consumption.
- The wide speed range from 400 RPM to 2800 RPM, combined with large size cartridge displacements, will optimize operation for the lowest noise level in the smallest envelope.
- The low speed 400 RPM, low pressure, high viscosity 9240 SUS allow application in cold environments with minimum energy consumption and without seizure risk.
- The low ripple pressure ± 29 PSI reduces piping noise and increases life time of other components in the circuit.
- The high resistance to particle contamination because of the double lip vane increases pump life.
- The large variety of options (cam displacement, shaft, porting) allows customized installation.
- The shaft option T (SAE J718c), allows direct drive (at 540 or 1000 RPM) on tractors.
- The double shaft seal (T6*P version) and drain hole allow direct mounting onto gear boxes.

SHAFTS AND HYDRAULIC FLUIDS - T6 SERIES MOBILE APPLICATION

RECOMMENDED FLUIDS	<p>Petroleum based antiwear R & O fluids. These fluids are the recommended fluids for T6 series pumps. Maximum catalog ratings and performance data are based on operation with these fluids. These fluids are covered by DENISON Hydraulics HF-0 and HF-2 specification.</p>																		
ACCEPTABLE ALTERNATE FLUIDS	<p>The use of fluids other than petroleum based antiwear R & O fluids, requires that the maximum ratings of the pumps will be reduced. In some cases the minimum replenishment pressures must be increased. Consult specific sections for more details.</p>																		
VISCOSITY	<table border="0"> <tr> <td>Max (cold start, low speed & pressure) _____</td> <td style="text-align: right;">9240 (SUS)</td> </tr> <tr> <td>Max (full speed & pressure) _____</td> <td style="text-align: right;">500 (SUS)</td> </tr> <tr> <td>Optimum (max. life) _____</td> <td style="text-align: right;">140 (SUS)</td> </tr> <tr> <td>Min (full speed & pressure for HF-1, HF-3, HF-4 & HF-5 fluids) _____</td> <td style="text-align: right;">90 (SUS)</td> </tr> <tr> <td>Min (full speed & pressure for HF-0 & HF-2 fluids) _____</td> <td style="text-align: right;">60 (SUS)</td> </tr> </table>	Max (cold start, low speed & pressure) _____	9240 (SUS)	Max (full speed & pressure) _____	500 (SUS)	Optimum (max. life) _____	140 (SUS)	Min (full speed & pressure for HF-1, HF-3, HF-4 & HF-5 fluids) _____	90 (SUS)	Min (full speed & pressure for HF-0 & HF-2 fluids) _____	60 (SUS)								
Max (cold start, low speed & pressure) _____	9240 (SUS)																		
Max (full speed & pressure) _____	500 (SUS)																		
Optimum (max. life) _____	140 (SUS)																		
Min (full speed & pressure for HF-1, HF-3, HF-4 & HF-5 fluids) _____	90 (SUS)																		
Min (full speed & pressure for HF-0 & HF-2 fluids) _____	60 (SUS)																		
VISCOSITY INDEX	<p>90° min. higher values extend range of operating temperatures.</p> <table border="0"> <tr> <td colspan="2">Maximum fluid temperature (θ) °F</td> </tr> <tr> <td>HF-0, HF-1, HF-2 _____</td> <td style="text-align: right;">+ 212</td> </tr> <tr> <td>HF-3, HF-4 _____</td> <td style="text-align: right;">+ 122</td> </tr> <tr> <td>HF-5 _____</td> <td style="text-align: right;">+ 158</td> </tr> <tr> <td>Biodegradable fluids (esters & rapeseed base) _____</td> <td style="text-align: right;">+ 149</td> </tr> <tr> <td colspan="2">Minimum fluid temperature (θ) °F</td> </tr> <tr> <td>HF-0, HF-1, HF-2, HF-5 _____</td> <td style="text-align: right;">- 0.4</td> </tr> <tr> <td>HF-3, HF-4 _____</td> <td style="text-align: right;">+ 50</td> </tr> <tr> <td>Biodegradable fluids (esters & rapeseed base) _____</td> <td style="text-align: right;">- 4.4</td> </tr> </table>	Maximum fluid temperature (θ) °F		HF-0, HF-1, HF-2 _____	+ 212	HF-3, HF-4 _____	+ 122	HF-5 _____	+ 158	Biodegradable fluids (esters & rapeseed base) _____	+ 149	Minimum fluid temperature (θ) °F		HF-0, HF-1, HF-2, HF-5 _____	- 0.4	HF-3, HF-4 _____	+ 50	Biodegradable fluids (esters & rapeseed base) _____	- 4.4
Maximum fluid temperature (θ) °F																			
HF-0, HF-1, HF-2 _____	+ 212																		
HF-3, HF-4 _____	+ 122																		
HF-5 _____	+ 158																		
Biodegradable fluids (esters & rapeseed base) _____	+ 149																		
Minimum fluid temperature (θ) °F																			
HF-0, HF-1, HF-2, HF-5 _____	- 0.4																		
HF-3, HF-4 _____	+ 50																		
Biodegradable fluids (esters & rapeseed base) _____	- 4.4																		
FLUID CLEANLINESS	<p>The fluid must be cleaned before and during operation to maintain contamination level of NAS 1638 class 8 (or ISO 18/14) or better. Filters with 25 micron (or better β10 ≤ 100) nominal ratings may be adequate but do not guarantee the required cleanliness levels. Suction strainers must be of adequate size to provide minimum inlet pressure specified. 100 mesh (149 micron) is the finest mesh recommended. Use oversize strainers or omit them altogether on applications which require cold starts or use fire resistant fluids.</p>																		
OPERATING TEMPERATURES AND VISCOSITIES	<p>Operating temperatures are a function of fluid viscosities, fluid type, and the pump. Fluid viscosity should be selected to provide optimum viscosity at normal operating temperatures. For cold starts the pumps should be operated at low speed and pressure until fluid warms up to an acceptable viscosity for full power operation.</p>																		
WATER CONTAMINATION IN THE FLUID	<p>Maximum acceptable content of water.</p> <ul style="list-style-type: none"> • 0,10 % for mineral base fluids. • 0,05 % for synthetic fluids, crankcase oils, biodegradable fluids. <p>If amount of water is higher, then it should be drained off the circuit.</p>																		
COUPLINGS AND FEMALE SPLINES	<ul style="list-style-type: none"> • The mating female spline should be free to float and find its own center. If both members are rigidly supported, they must be aligned within .006 TIR or less to reduce fretting. The angular alignment of two spline axes must be less than ± .002" per 1" radius. • The coupling spline must be lubricated with a lithium molydisulfide grease or a similar lubricant. • The coupling must be hardened to a hardness between 27 and 45 R.C. • The female spline must be made to conform to the Class 1 fit as described in SAE-J498b (1971). This is described as a Flat Root Side Fit. 																		
KEYED SHAFTS	<p>DENISON Hydraulics supplies the T6 series keyed shaft pumps with high strength heat-treated keys. Therefore, when installing or replacing these pumps, the heat-treated keys must be used in order to insure maximum life in the application. If the key is replaced it must be a heat-treated key between 27 and 34 R.C. hardness. The corners of the keys must be chamfered from .030" to .040 at 45° to clear radii in the key way.</p>																		
NOTE	<p>Alignment of keyed shafts must be within tolerances given for splined shafts.</p>																		
SHAFT LOADS	<p>These products are designed primarily for coaxial drives which do not impose axial or side loading on the shaft. Consult specific sections for more details.</p>																		

INTERNAL LEAKAGE (TYPICAL)

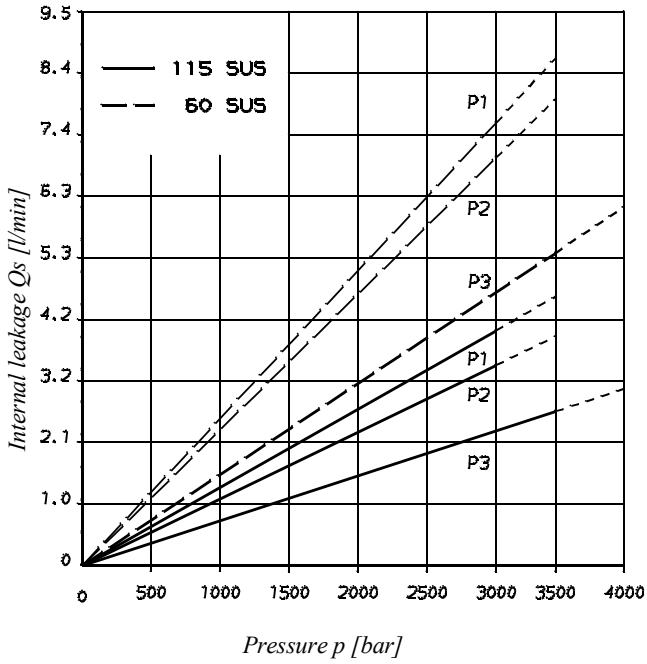

Total leakage is the sum of each section loss at its operating conditions.

NOISE LEVEL (TYPICAL)

T6EDCM - 062 - B35 - B17

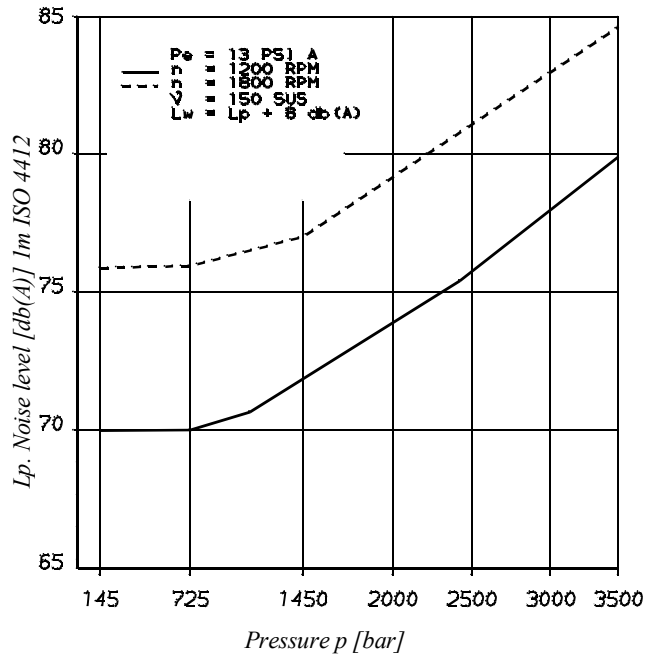

Triple pump noise level is given with each section discharging at the pressure noted on the curve.

POWER LOSS HYDROMECHANICAL (TYPICAL)

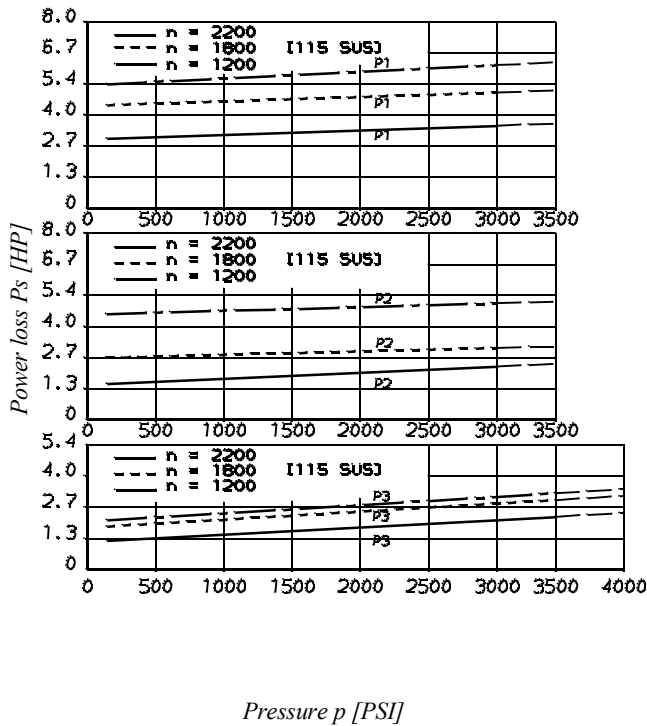

Total hydrodynamic power loss is the sum of each section at its operating conditions.

PERMISSIBLE RADIAL LOAD

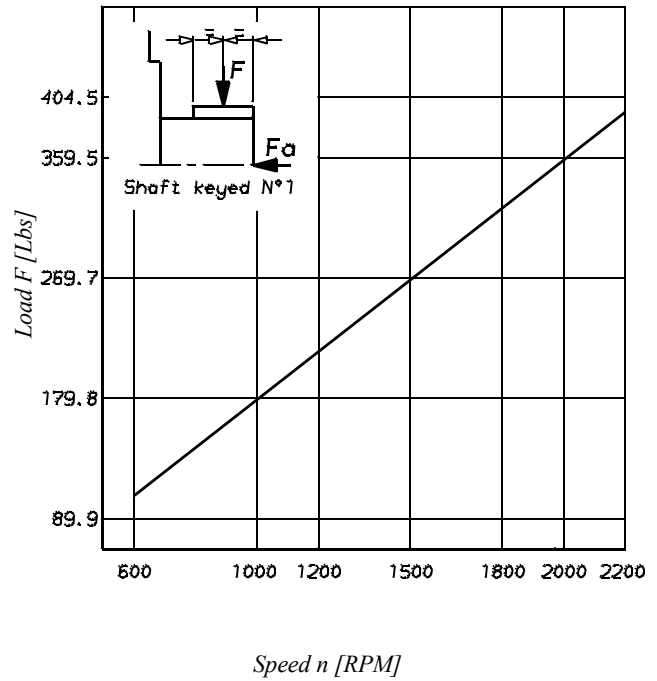

Maximum permissible axial load Fa = 449 Lbs

Alternate port				
Port	Code	A	B	C
P3	0	2.06	1.03	1.00
P3	1	1.87	.87	.75

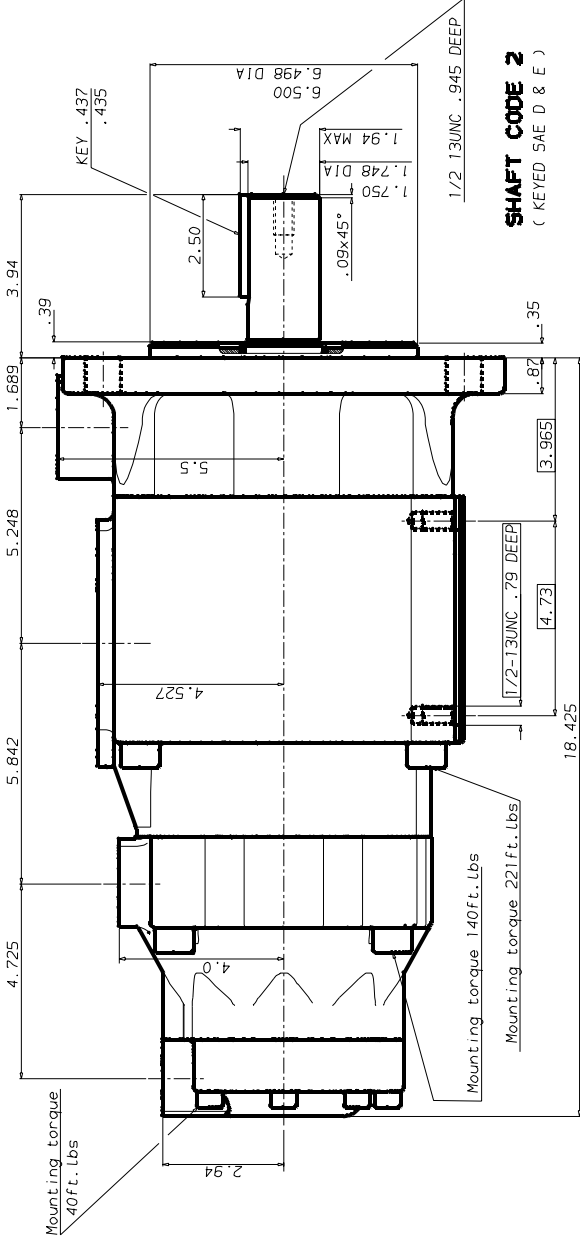
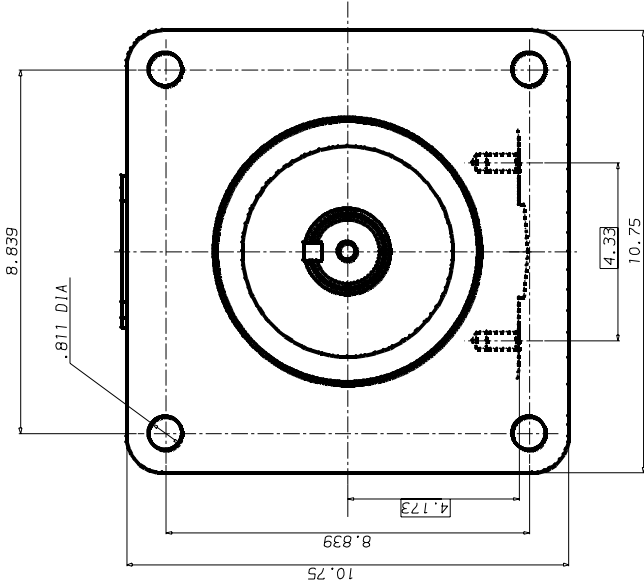
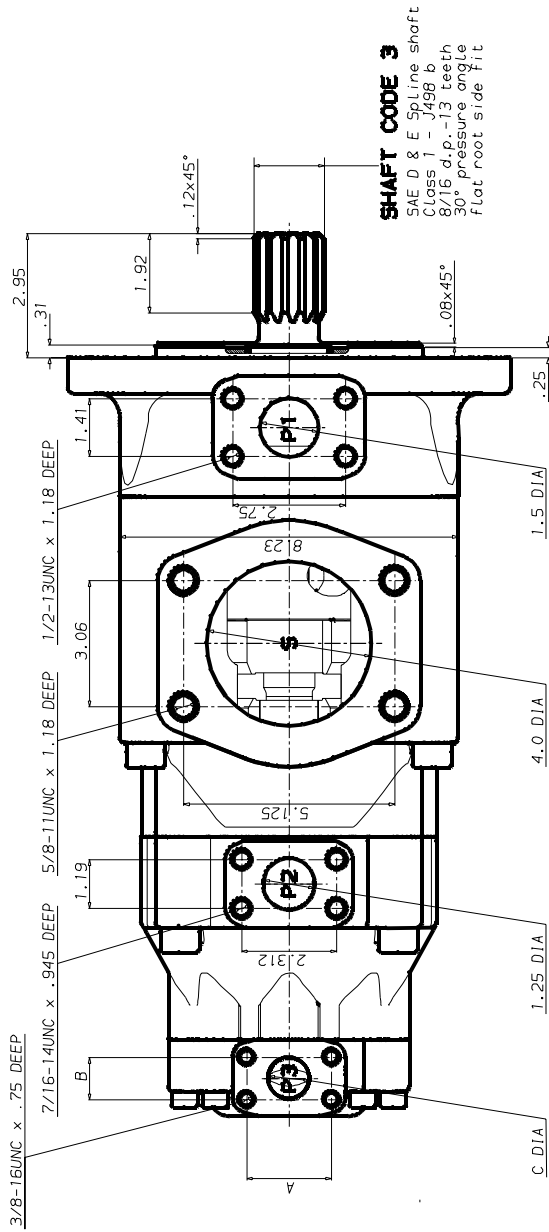

ADDITIONAL SHAFTS - T6 SERIES MOBILE APPLICATION

ADDITIONAL P VERSION

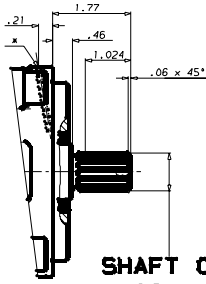

T6CCP
Shaft torque limits
18246 [in³/rev x PSI]

SHAFT CODE 3

no SAE splined shaft
Class 1 - J498b
16/32 pitch- 13 teeth
30° pressure angle
Flat root side fit

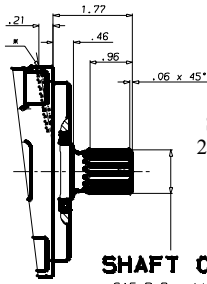

T6CCP
Shaft torque limits
28937 [in³/rev x PSI]

SHAFT CODE 4

SAE B-B splined shaft
Class 1 - J498b
16/32 pitch- 15 teeth
30° pressure angle
Flat root side fit

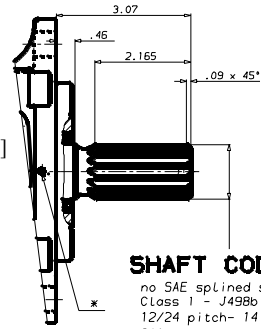

T6CCP
Shaft torque limits
28937 [in³/rev x PSI]

SHAFT CODE 6

no SAE splined shaft
Class 1 - J498b
12/24 pitch- 14 teeth
30° pressure angle
Flat root side fit

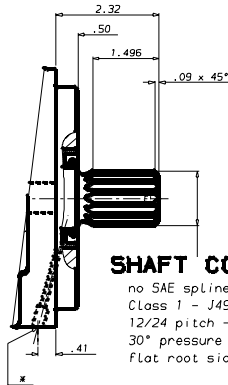

T6DP

SHAFT CODE 3

no SAE splined shaft
Class 1 - J498b
12/24 pitch- 14 teeth
30° pressure angle
Flat root side fit

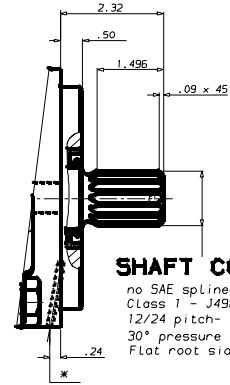

T6DCP

SHAFT CODE 3

no SAE splined shaft
Class 1 - J498b
12/24 pitch- 14 teeth
30° pressure angle
Flat root side fit

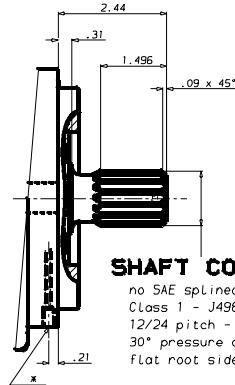

T6EP-T6ECP
T6EDP

Shaft torque limits
54207 [in³/rev x PSI]

SHAFT CODE 3

no SAE splined shaft
Class 1 - J498b
12/24 pitch- 14 teeth
30° pressure angle
Flat root side fit

* Drain hole between double shaft seals.

ADDITIONAL SHAFT CODE T : 540 RPM POWER TAKE-OFF - SAE J718C FOR FARM TRACTORS

T6DM

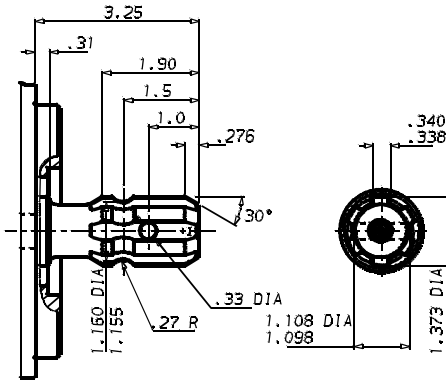

Shaft torque limits
T6CCMW - 28937 [in³/rev x PSI]
T6DCMW - 58990 [in³/rev x PSI]
T6EM - T6ECM - T6EDM - 63256 [in³/rev x PSI]

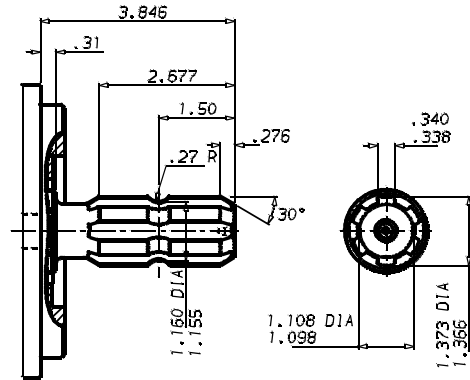

ADDITIONAL SPECIAL T6CCMW SHAFTS

Shaft Code R
Shaft torque limits
16032 [in³/rev x PSI]

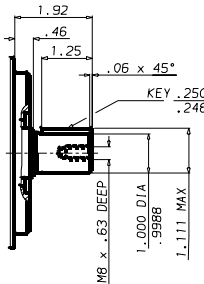

Shaft Code V
Shaft torque limits
28937 [in³/rev x PSI]

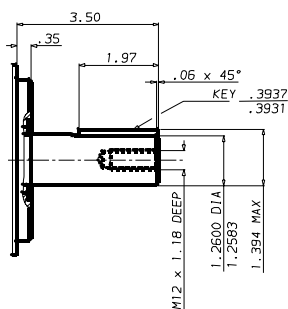

Shaft Code X
Shaft torque limits
22498 [in³/rev x PSI]

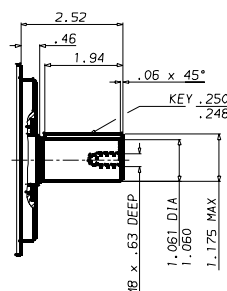

Shaft Code W
Shaft torque limits
28937 [in³/rev x PSI]

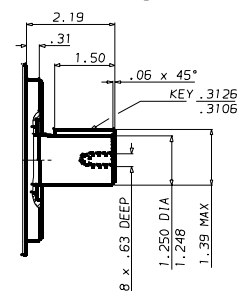

PORTING DIAGRAMS - T6 SERIES MOBILE APPLICATION

T6CC* - T6DC* - T6EC*

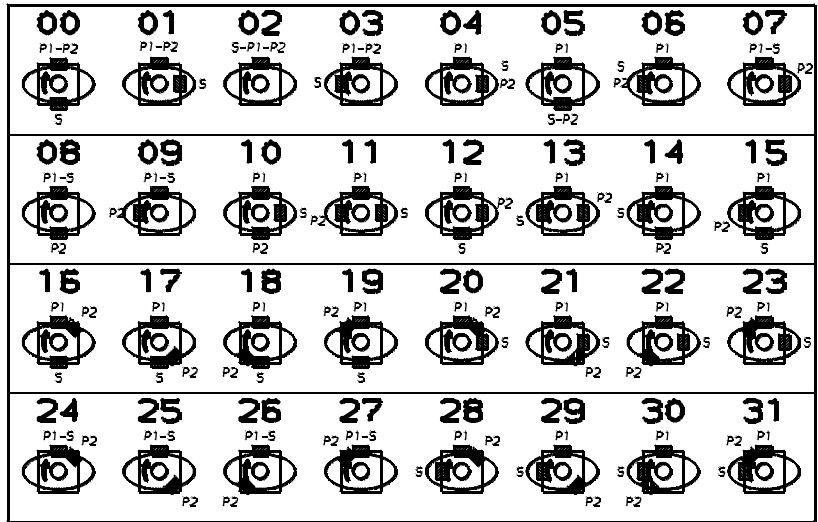

T6ED*

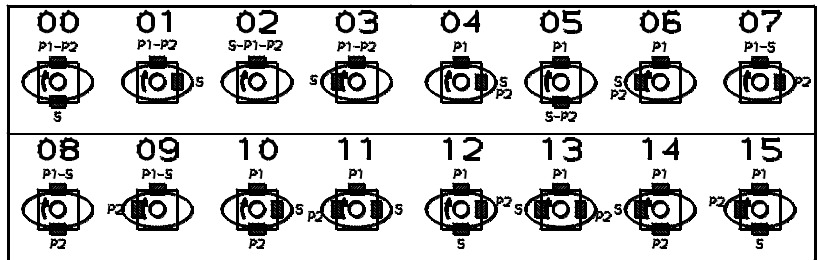



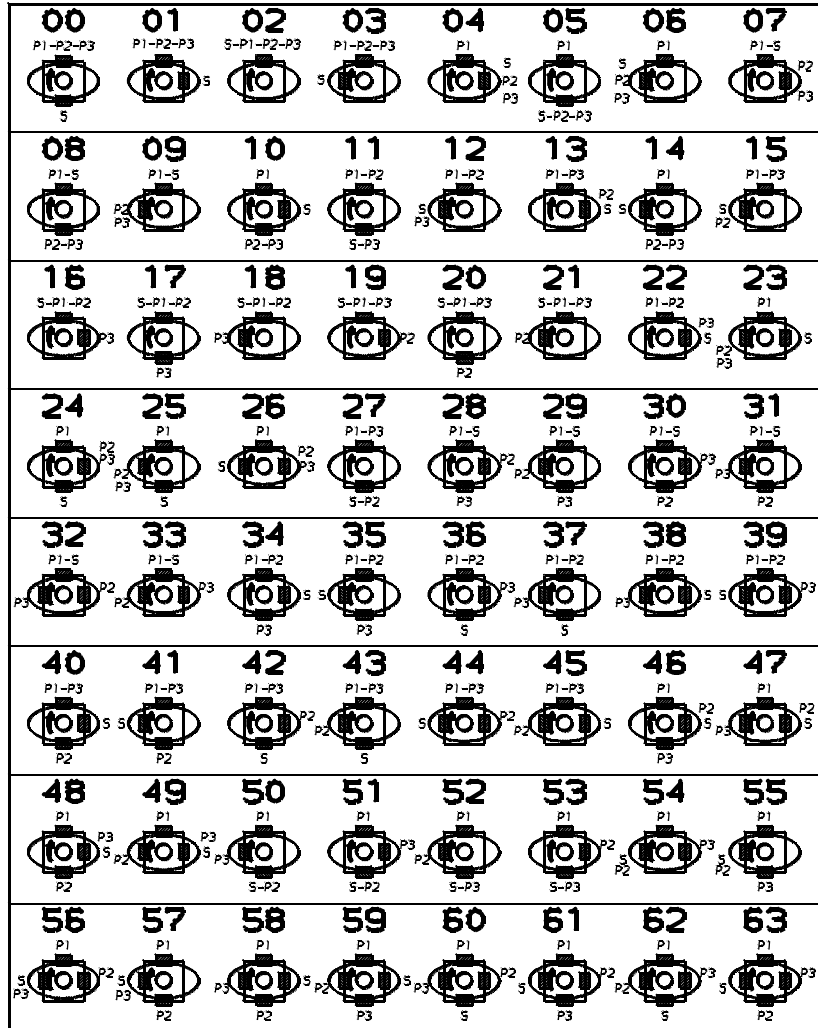

















T6DCCM - T6EDC*



PORTING DIAGRAMS - T6 SERIES MOBILE APPLICATION

T6DCCM - T6EDC*

P1

S	P2	P3				P2	P3			
		02	16	17	18		20	30	08	31
		19	07	28	32		21	33	29	09
		01	22	34	38		40	48	10	58
		13	04	46	47		45	49	59	23
		00	36	11	37		27	51	05	50
		42	24	53	60		43	62	52	25
		03	39	35	12		41	63	14	57
		44	26	61	56		15	54	55	06