

Introduction

Manapak valves provide a variety of check, flow control, pressure relief and pressure reducing functions in a compact NFPA D03, D05 and D08 sandwich style valve. The NFPA D03 valve body conforms to the ISO 40 mm (1.57") thickness. These valves are mounted between directional control valves and their mounting surface.

The NFPA D03 Manapak valves may also be used in conjunction with Parker's Cartpak Series of sandwich valves which offer a wide variety of additional functions including relief, pressure reducing/relieving, load check, back pressure check, needle, flow control, pressure compensated flow control, crossover, relief and directional valves.

B

Check Valves
Series CM

- Valve bodies are manufactured from steel which provide extra strength and durability for longer life. Internal hardened steel components also provide longer life.
- Positive shut-off is provided by a fully guided poppet and allows full flow in the unchecked position.
- Parker Manapak CM sandwich style check valves can be used either on the 'P', 'A', 'B', 'T' port or combination.
- Large internal flow paths allow high flow at low pressure drop.

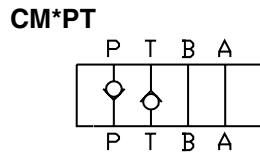
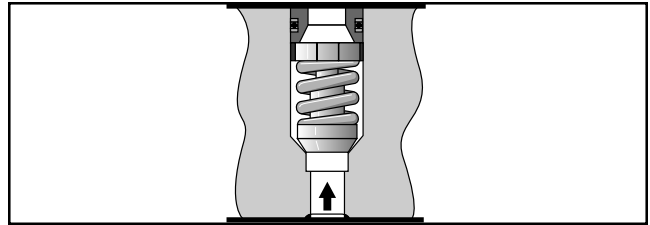

CM*AA

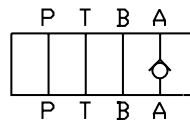

CM*AAF

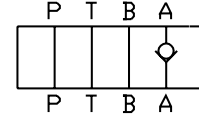

CM*BB

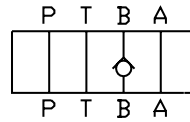

CM*BBF

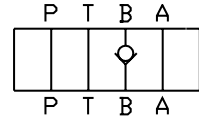

CM*DD

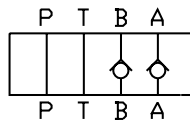

CM*DDF

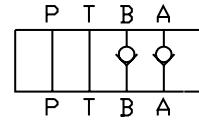

CM*PP

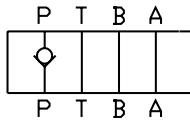

CM*TT

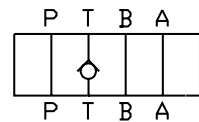

P. O. Check Valves
Series CPOM

- Parker Manapak CPOM sandwich style, pilot operated check valves can be provided in either single or double configurations.
- The pilot operated checks may be positioned in 'A' port or 'B' port; or both 'A' and 'B' ports.
- Valve bodies are manufactured from steel which provide extra strength and durability for longer life. Internal hardened steel components also provide longer life.
- Positive shut-off is provided by a hardened poppet and cage assembly.
- Large internal flow paths allow high flow at low pressure drop.

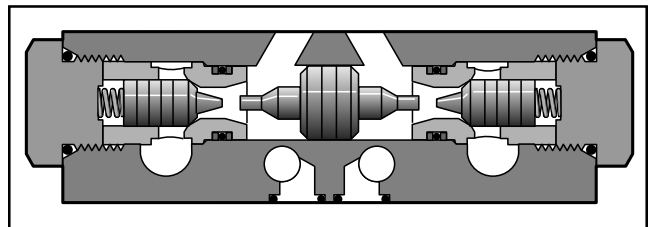

CPOM*AA

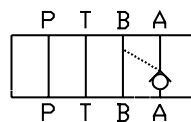

CPOM*BB

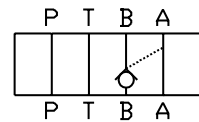

CPOM*DD

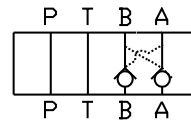

Flow Control Valves

Series FM

- Parker Manapak style FM flow control valves can be provided in either single or double configurations.

The flow controls may be positioned in 'P' port, 'A' port, 'B' port, or both 'A' and 'B' ports.

- Valve bodies are manufactured from steel which provide extra strength and durability for longer life. Internal hardened steel components also provide longer life.
- Two step needles (standard) provide fine adjustment for the first three turns and course adjustment for the last three turns. Fine metering needles are available as an option.
- Large bypass checks allow high flow at a low pressure drop.
- Reversible (invert 180°) for meter-in or meter-out (D03 & D05 only).

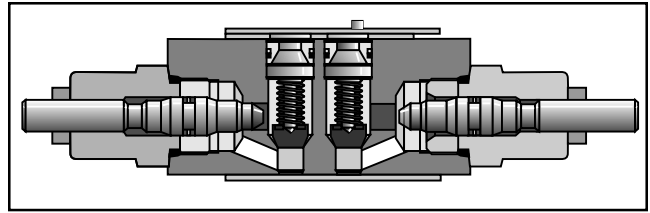

FM*AA

(Meter Out)

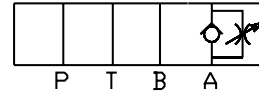

FM*BB

(Meter Out)

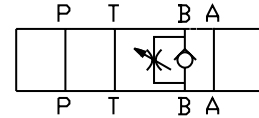

FM*DD

(Meter Out)

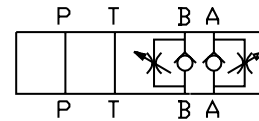

FM*PP

(Meter Out)

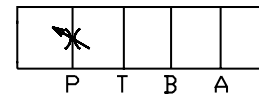

Pressure Reducing Valves

Series PRDM

- PRDM Manapak sandwich valves may be selected to reduce pressure in the 'P' port, 'A' port or 'B' port.
- The direct operated, cushioned piston design results in fast response, low leakage and minimal hysteresis.
- Up to four pressure adjustment ranges are available with maximum pressure settings of 25, 64, 160 and 210 Bar (363, 928, 2320, 3045 PSI).
- Adjustment options include: internal hex screw, hand knob or internal hex with keylock.
- Fluorocarbon seals are standard for multi-fluid compatibility.
- Available gage port connections include: SAE, NPT, BSPP Metric and ISO 6149.

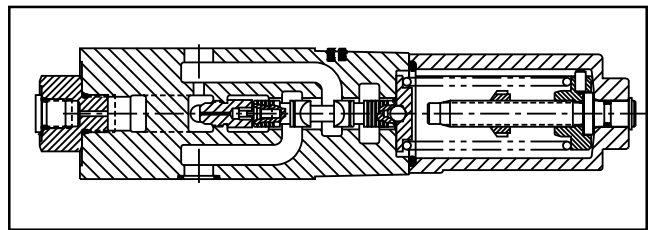

PRDM*PP

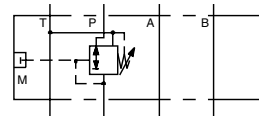

PRDM*AA

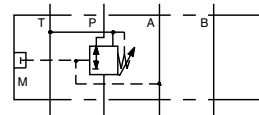

PRDM*BB

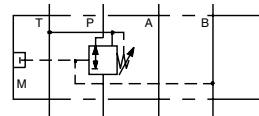

Pressure Reducing Valves

Series PRM

- Parker Manapak PRM sandwich style pressure reducing valves can be used to reduce pressure on the 'P' port, the 'A' port, or the 'B' port.
- Three pressure adjustment options available: slotted screw, knob and locking knob.
- Valve bodies are manufactured from steel which provide extra strength and durability for longer life. Internal hardened steel components also provide longer life.

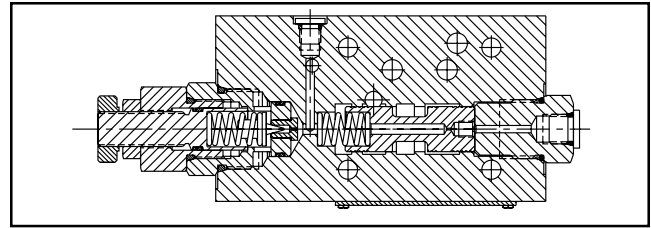

PRM*AA

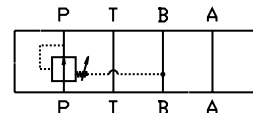

PRM*BB

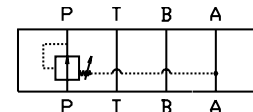

PRM*PP

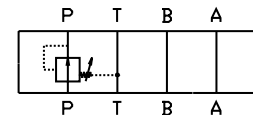

Pressure Relief Valves

Series RM

- Parker Manapak RM sandwich style relief valve is a 'P' port to 'T' port relief.
- Valve bodies are manufactured from steel which provide extra strength and durability for longer life. Internal hardened steel components also provide longer life.
- Three pressure adjustment options available: slotted screw, knob and locking knob.

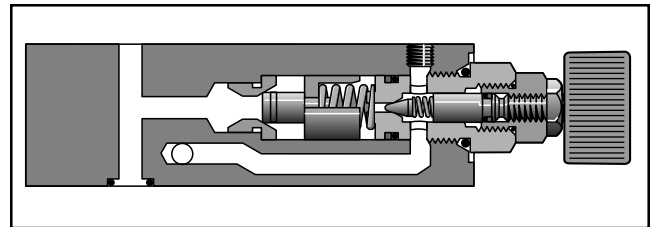

RM*PT

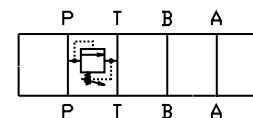

Inch equivalents for millimeter dimensions are shown in (**)

B

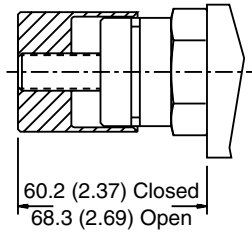

Knob Option

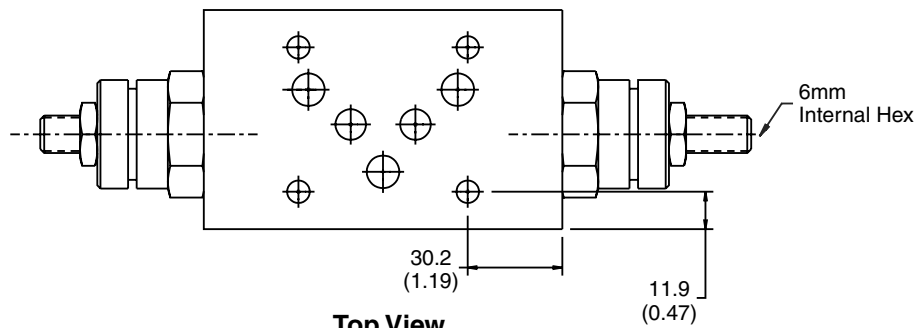

Top View

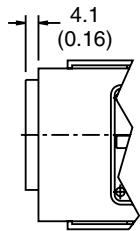

AA Option

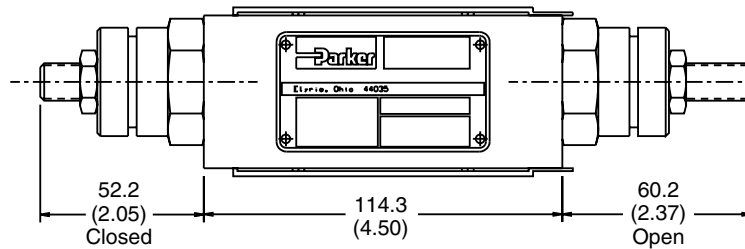

Face View

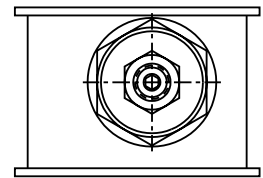

End View

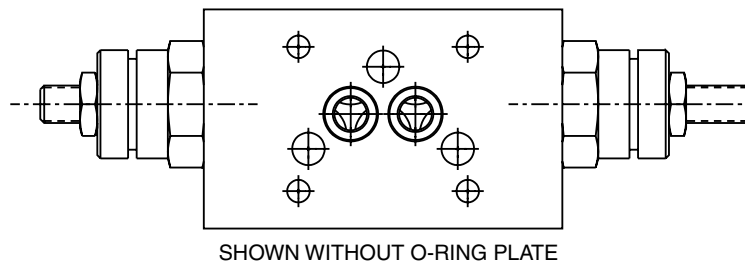

Bottom View

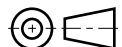

B

CAUTION:
Manapak Installation

Prior to installation of Manapaks, please review flow paths. Due to the reversibility of the DO3 size, incorrect installation will alter the hydraulic circuit. Care must be taken during installation to insure that the Manapak is installed in compliance with the hydraulic schematic. Please consult with your Parker representative with any questions that may arise.

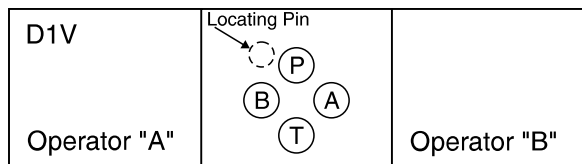

Pressure Ratings

Unless otherwise specified, all Parker Manapaks have continuous duty pressure rating as shown in this catalog.

Special Requirements

Consult your Parker representative for factory recommendations on such situations as:

- Installations that will operate at pressures higher than published catalog ratings.
- Use of hydraulic fluids which do not meet our recommended specifications.
- Operations where fluid temperature will exceed 121°C (250°F).

Recommended Mounting Surface

Surface must be flat within .0004 inch T.I.R. and smooth with 32 micro-inch.

System Cleanliness

Any hydraulic system that includes Parker valves should be carefully protected against dirt and fluid contamination. Life of the valves, as well as of all other components, will be greatly lengthened. Operation will be smoother and more precise. Maintenance and repairs will be reduced. Lost production because of low pressure and flow will be minimized. Fluid contamination should be maintained to less than 500 particles larger than 10 micrometers per milliliter of fluid (SAE class 4 or better/ISO Code 16/13).

Hydraulic Fluids

Parker recommends using top-quality hydraulic fluids having a viscosity range of 150 to 250 SSU (32 to 54 cst.) at 38°C (100°F). The absolute viscosity range should be 80 to 1000 SSU (16 to 220 cst.). Fluids should have highest anti-wear characteristics and be treated to avoid rust and oxidation.

Seals

When used with water-glycol, water/oil emulsions, and high-grade petroleum base hydraulic fluids, Parker standard nitrile seals are suitable.

When using phosphate ester fluids or their blends, specify Parker optional seals made of fluorocarbon. Synthetic fire-resistant fluids require special seal materials which your Parker representative can recommend.

Torque Specifications

The recommended torque valves are for the bolts which mount the valve to the manifold or subplate are as follows:

Size	Torque Valve
2	5.7 N.m. (50 in.-lbs.)
3	16.3 N.m. (12 ft.-lbs.)
6	108.5 N.m. (80 ft.-lbs.)

Mounting Patterns

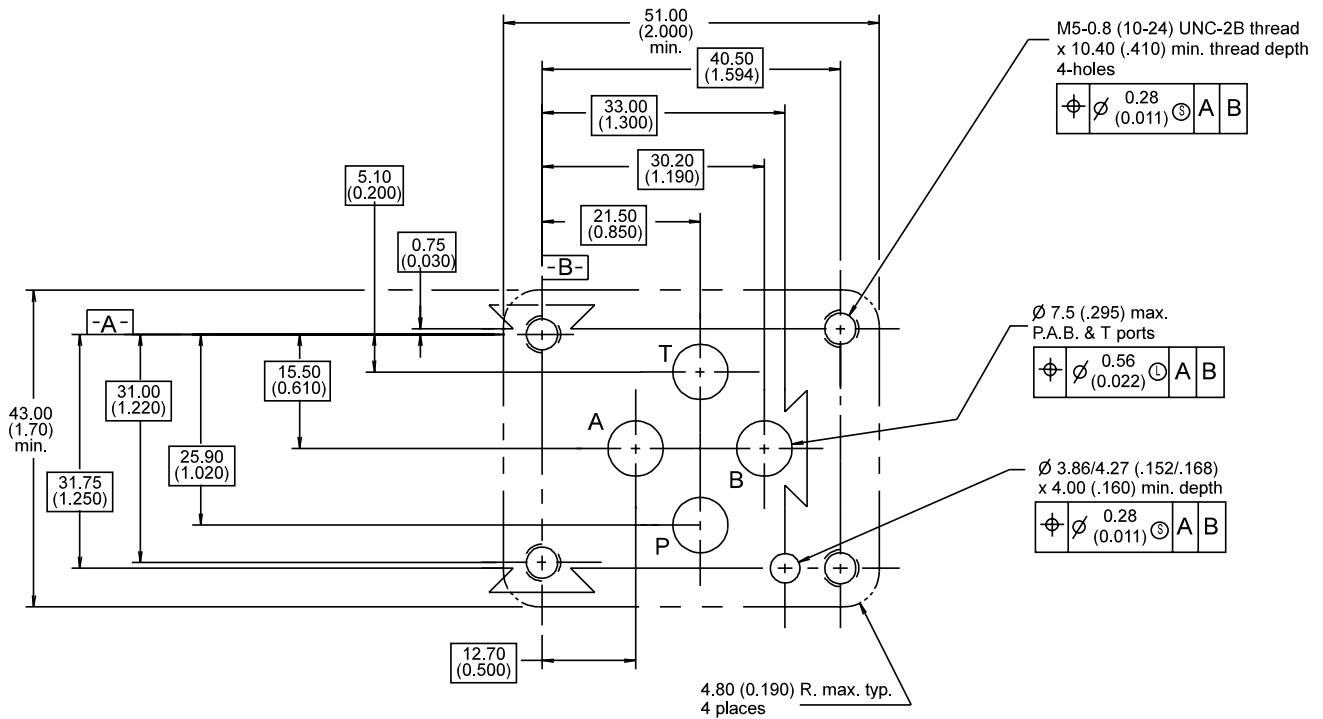

Mounting Surface for Directional Control Valve Manifold M'TD. (NFPA, D03); CETOP 3 & NG 6

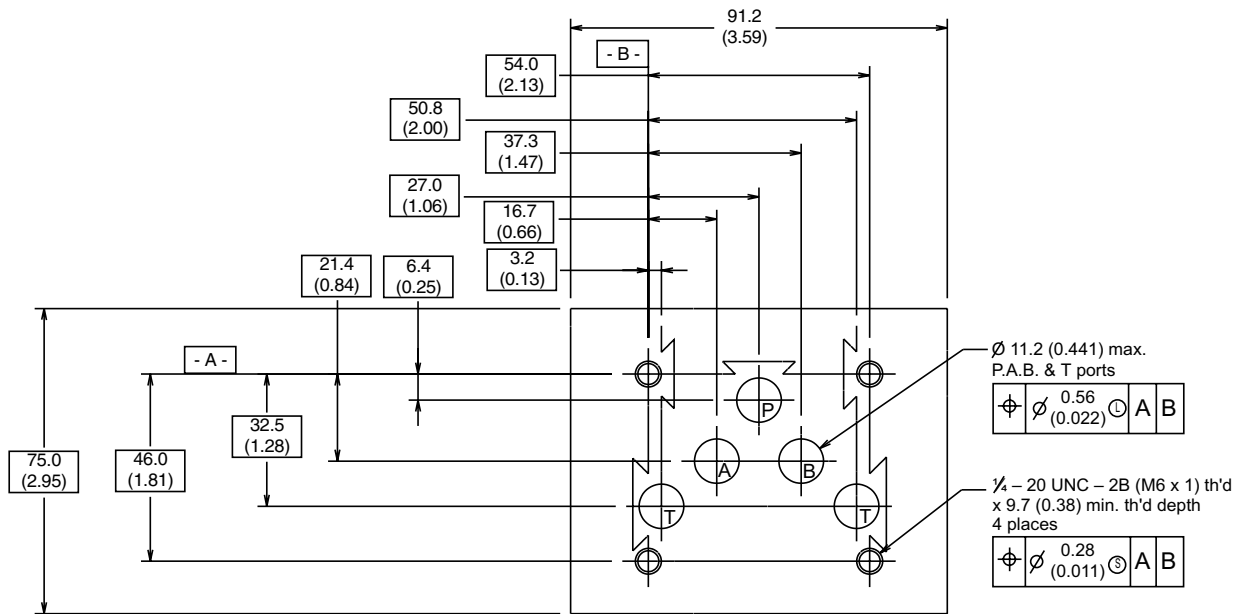

Mounting Surface for Directional Control Valve (NFPA, D05); CETOP 5 & NG 10

Mounting Patterns

B

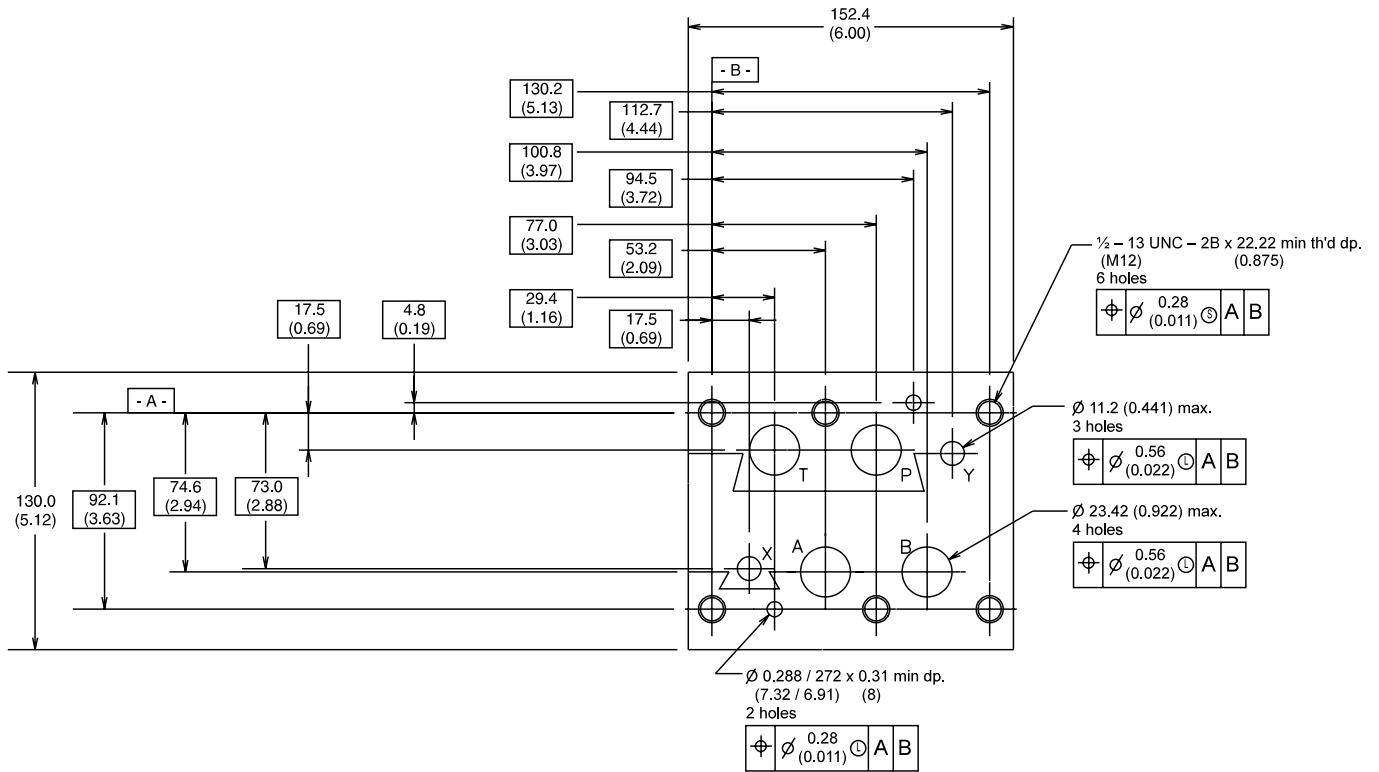

Mounting Surface for Directional Control Valve (NFPA, D08); CETOP 8 & NG 25