

Lynch MANIFOLDS & VALVE PACKS

D03 Subplate with Relief - Nominal 3/8"

SPRP_03GSPSCUCA

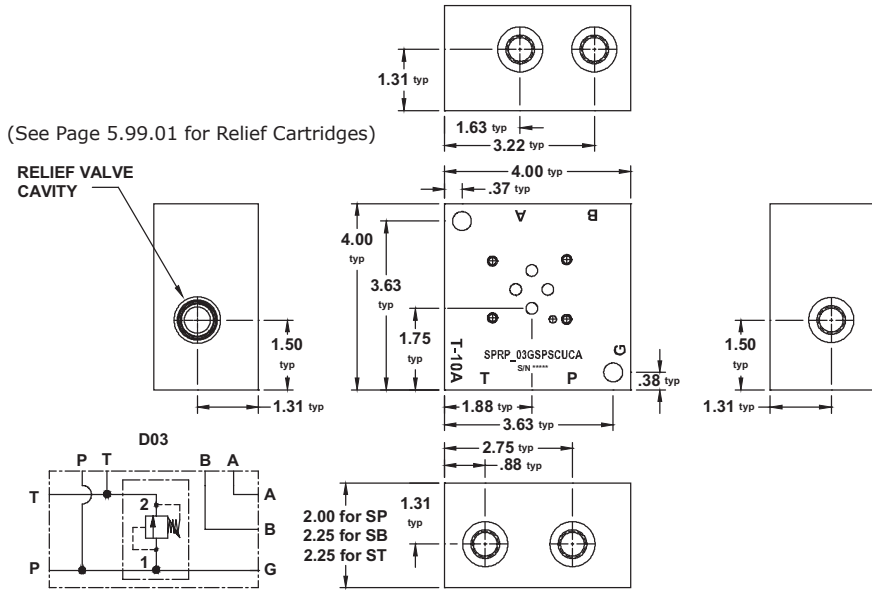

Mounting Kits include the following:

"SP" UNC Kit:
2 - 3/8"-16 x 2.75" SHCS
"SP" Metric Kit:
2 - M10-1.5 x 70 mm SHCS

"SB" UNC Kit:
2 - 3/8"-16 x 3.00" SHCS
2 - plugs
"SB" Metric Kit:
2 - M10-1.5 x 75 mm SHCS
2 - plugs

"ST" UNC Kit:
2 - 3/8"-16 x 3.00" SHCS
"ST" Metric Kit:
2 - M10-1.5 x 75 mm SHCS

SPRP_03GSBSCUCA - BOTTOM VIEW

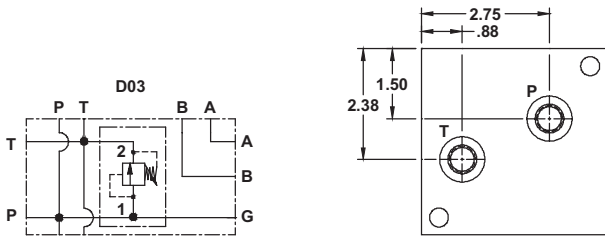

SPRP_03GSTSCUCA - BOTTOM VIEW

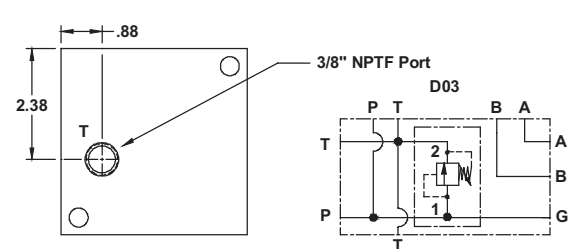

5
SUBPLATES
w/
CIRCUITS

PART NUMBER SYSTEM

Aluminum D03 Side Ported Subplate with SAE 6 Ports & T-10A Relief Example: **SPRPA03GSPSCUCA**

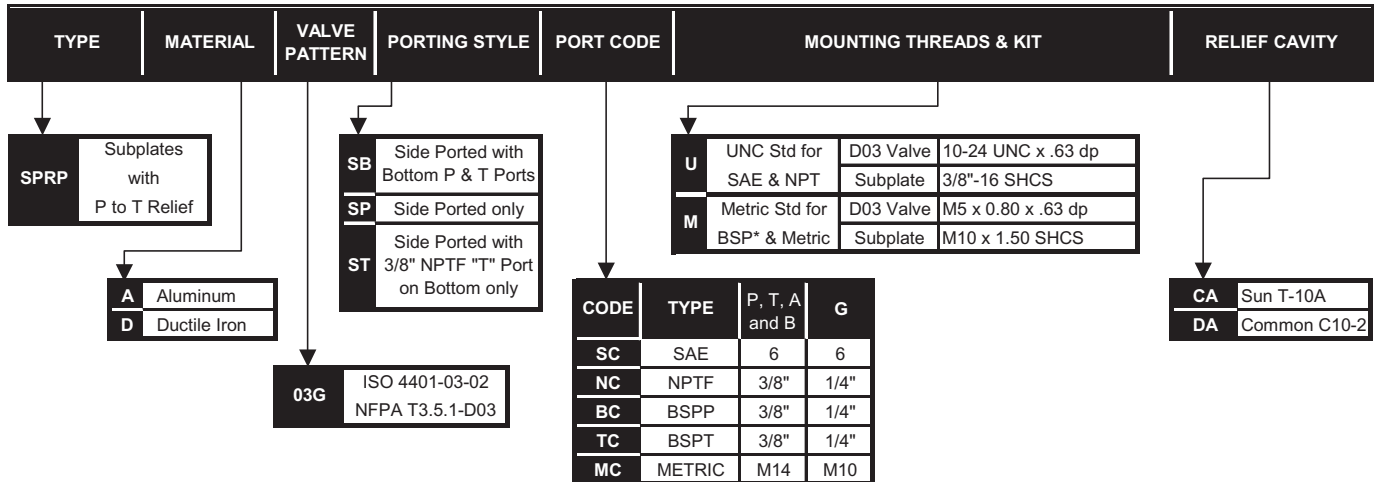

WE RESERVE THE RIGHT TO DISCONTINUE MODELS, OR CHANGE SPECIFICATIONS WITHOUT NOTICE OR INCURRING OBLIGATION

Lynch Products Can Be Modified to Suit Your Application



D03 Subplate with Relief - Nominal 1/2"

SPRP_03GSPSDUCA

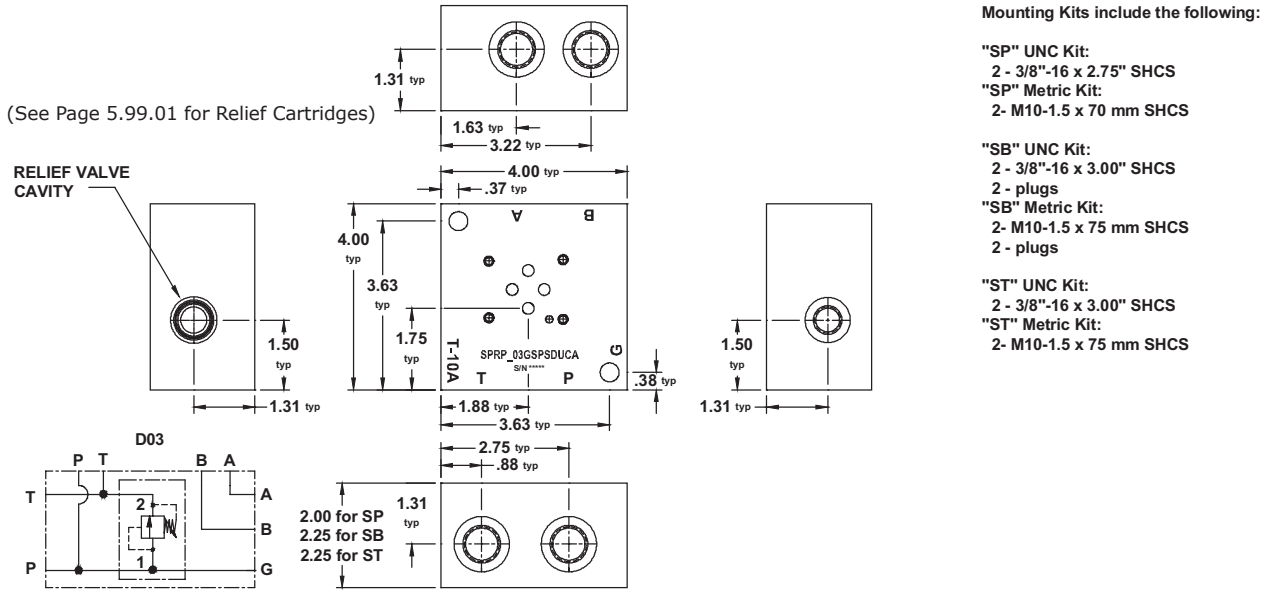

SPRP_03GSBSDUCA - BOTTOM VIEW

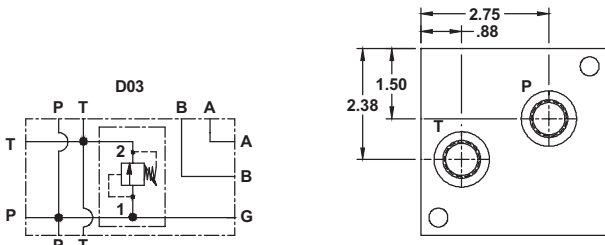

SPRP_03GSTSDUCA - BOTTOM VIEW

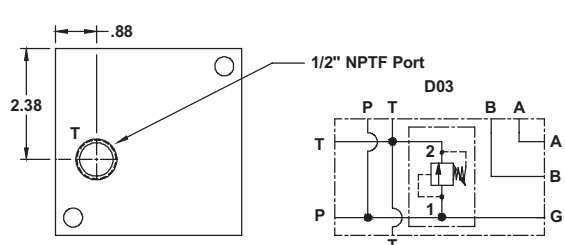

PART NUMBER SYSTEM

Aluminum D03 Side Ported Subplate with SAE 8 Ports & T-10A Relief Example: **SPRPA03GSPSDUCA**

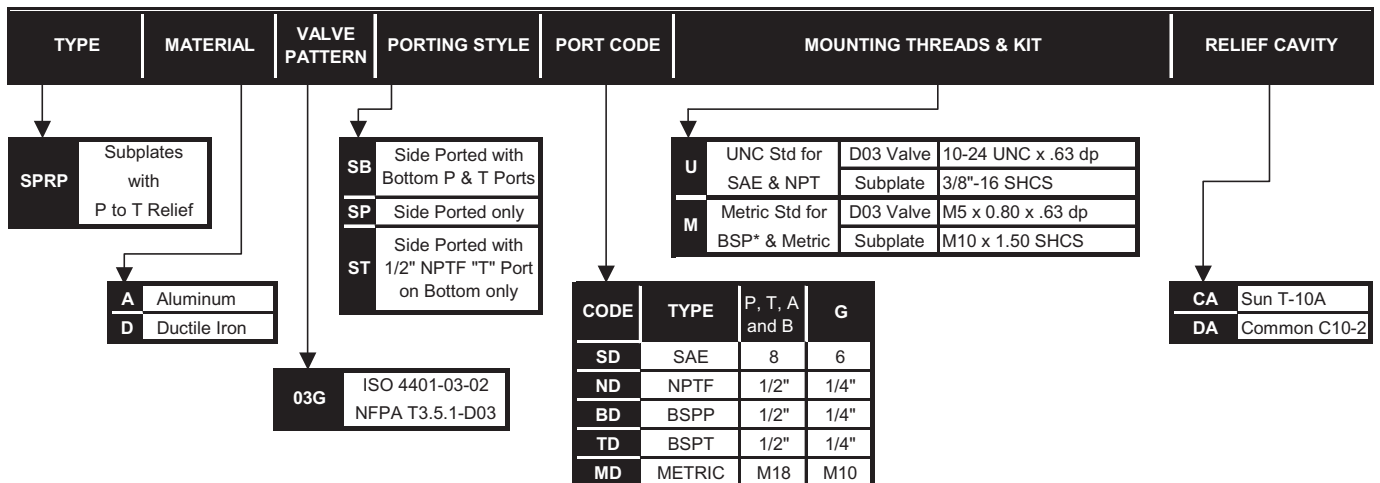

WE RESERVE THE RIGHT TO DISCONTINUE MODELS, OR CHANGE SPECIFICATIONS WITHOUT NOTICE OR INCURRING OBLIGATION

Lynch Products Can Be Modified to Suit Your Application

Lynch MANIFOLDS & VALVE PACKS

D03 Subplate with Relief - Nominal 3/4"

SPRP_03GSPSFUCA

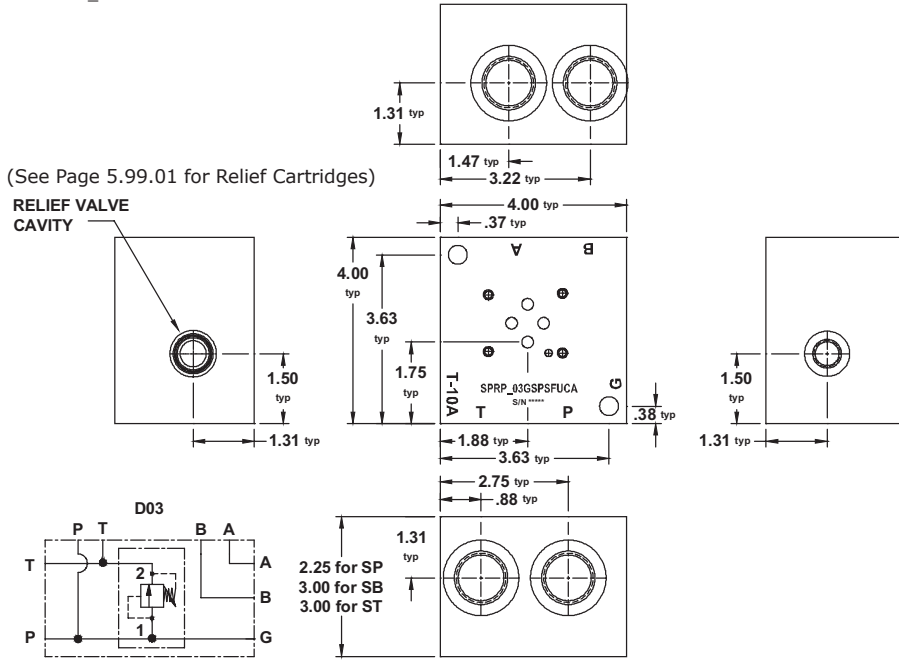

Mounting Kits include the following:

- "SP" UNC Kit:
2 - 3/8"-16 x 3.00" SHCS
- "SP" Metric Kit:
2 - M10-1.5 x 75 mm SHCS
- "SB" UNC Kit:
2 - 3/8"-16 x 3.50" SHCS
2 - plugs
- "SB" Metric Kit:
2 - M10-1.5 x 90 mm SHCS
2 - plugs
- "ST" UNC Kit:
2 - 3/8"-16 x 3.50" SHCS
- "ST" Metric Kit:
2 - M10-1.5 x 90 mm SHCS

SPRP_03GSBSFUCA - BOTTOM VIEW

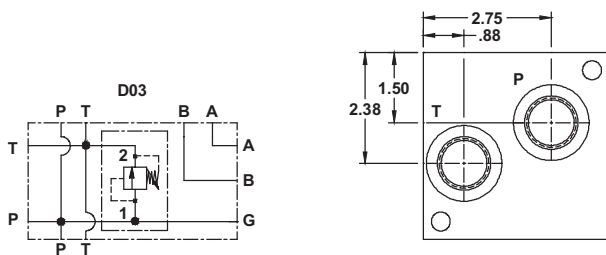

SPRP_03GSTSFUCA - BOTTOM VIEW

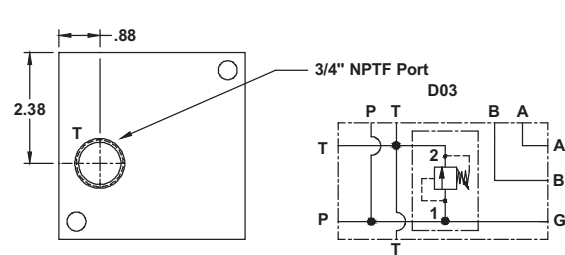

5
SUBPLATES
w/
CIRCUITS

PART NUMBER SYSTEM

Aluminum D03 Side Ported Subplate with SAE 12 Ports & T-10A Relief Example: **SPRPA03GSPSFUCA**

TYPE	MATERIAL	VALVE PATTERN	PORTING STYLE	PORT CODE	MOUNTING THREADS & KIT	RELIEF CAVITY	
SPRP	Subplates with P to T Relief		SB Side Ported with Bottom P & T Ports SP Side Ported only ST Side Ported with 3/4" NPTF "T" Port on Bottom only	U UNC Std for D03 Valve SAE & NPT Subplate M Metric Std for D03 Valve BSP* & Metric Subplate	10-24 UNC x .63 dp 3/8"-16 SHCS M5 x 0.80 x .63 dp M10 x 1.50 SHCS	CA Sun T-10A DA Common C10-2	
	A Aluminum D Ductile Iron	03G ISO 4401-03-02 NFPA T3.5.1-D03					
				CODE	TYPE	P, T, A and B	G
				SF	SAE	12	6
				NF	NPTF	3/4"	1/4"
				BF	BSPP	3/4"	1/4"
				TF	BSPT	3/4"	1/4"
				MF	METRIC	M27	M10

WE RESERVE THE RIGHT TO DISCONTINUE MODELS, OR CHANGE SPECIFICATIONS WITHOUT NOTICE OR INCURRING OBLIGATION

Lynch Products Can Be Modified to Suit Your Application



NFPA
Solutions through
motion technology
MEMBER

