

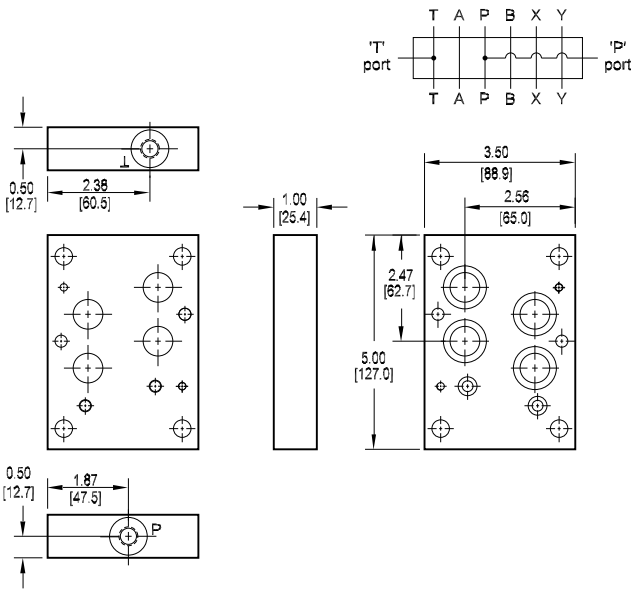

D07 Tapping Plates

P and T Port Tapping Plate

Tapping Plate interface seal kit is supplied. *
See page 124 for itemized list.
* Plug not supplied on metric ported parts.



A and B Port Tapping Plate

Tapping Plate interface seal kit is supplied. *
See page 124 for itemized list.
* Plug not supplied on metric ported parts.

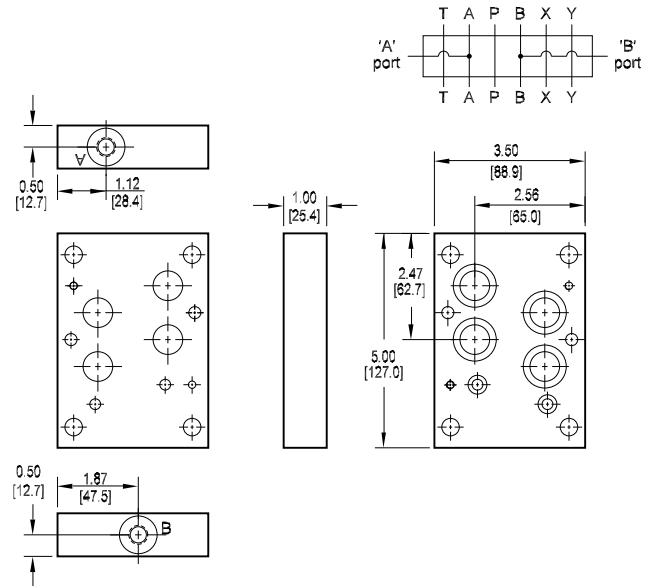

Specifications, descriptions, and dimensional data are subject to correction or change without notice or incurring obligation.

6 Ordering Information

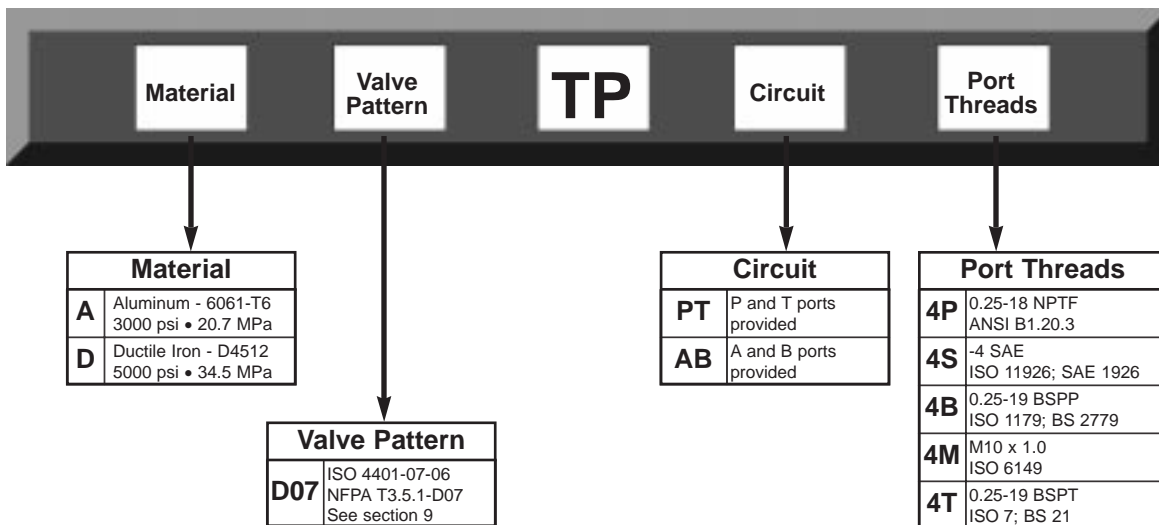



D07 Tapping Plates

X and Y Port Tapping Plate

Tapping Plate interface seal kit is supplied. *

See page 124 for itemized list.

* Plugs not supplied on metric ported parts.

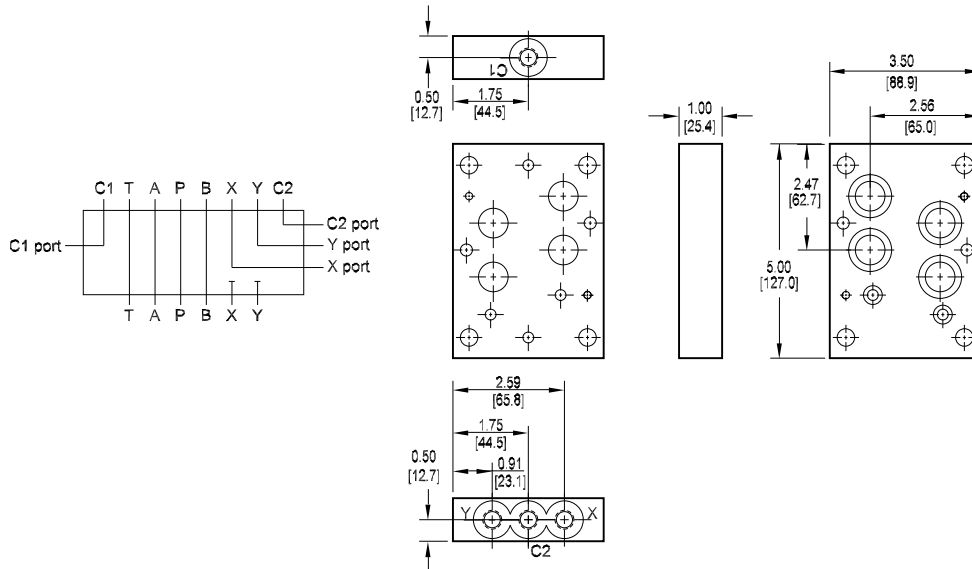

Specifications, descriptions, and dimensional data are subject to correction or change without notice or incurring obligation.

Ordering Information

6

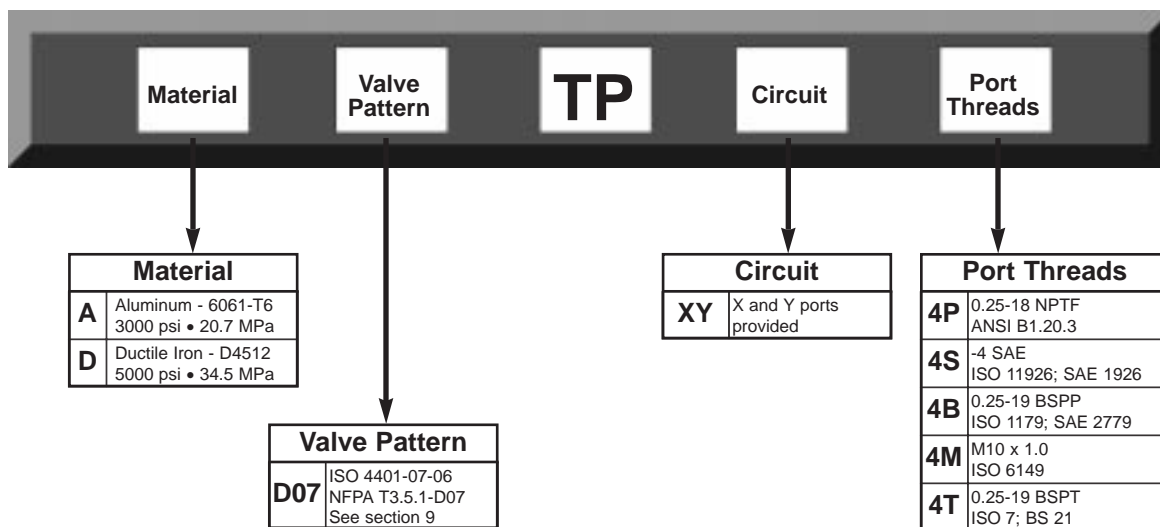



D07 Tapping Plates

Spot Drilled Tapping Plate

Tapping Plate interface seal kit is supplied.
See page 124 for itemized list.

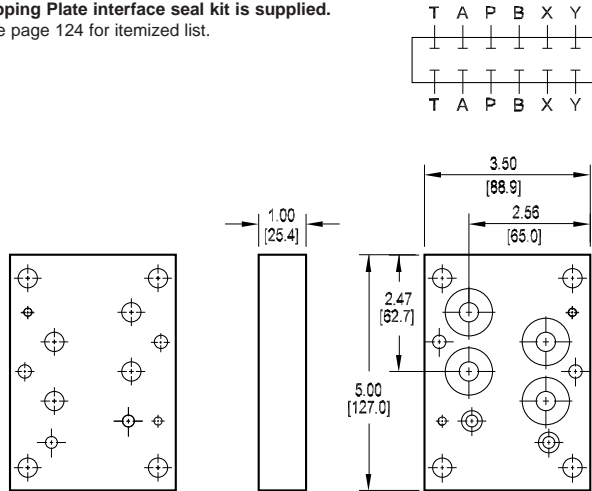

Specifications, descriptions, and dimensional data are subject to correction or change without notice or incurring obligation.

6 Ordering Information

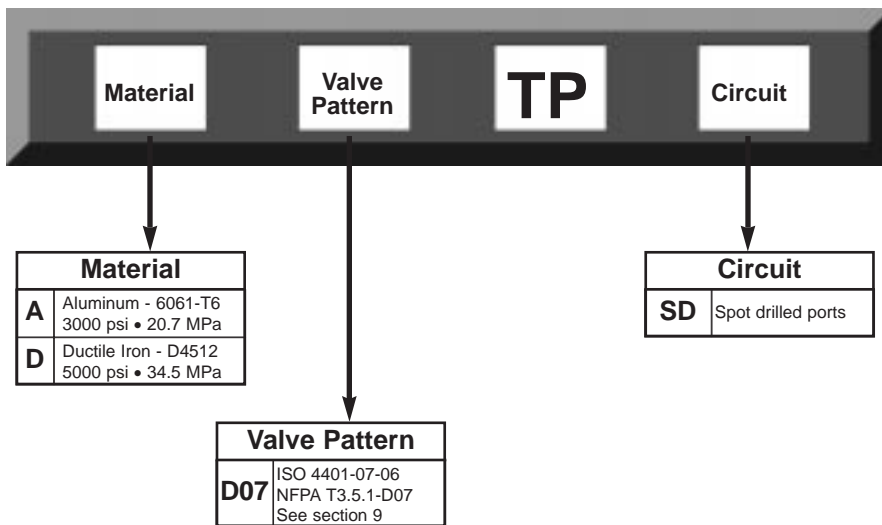



D07 Tapping Plates

D05-D07 Two Station Tapping Plate

A₁ common to A₂, B₁ common to B₂

D05 Valve mtg: UNC 0.25-20 x 0.75 [19] DP
Tapping Plate interface seal kit is supplied. *

See page 124 for itemized list.

* (6) bolts are user supplied and must pass through valve and tapping plate to thread into manifold.

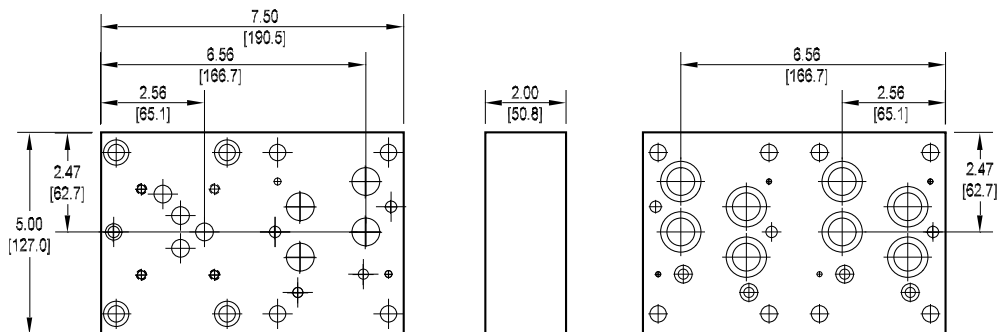
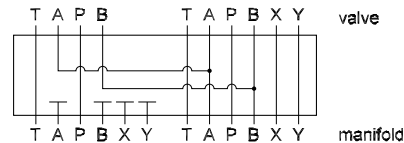

Specifications, descriptions, and dimensional data are subject to correction or change without notice or incurring obligation.

Ordering Information

6

